

LT-25 / LT-29 Quick Release Buckle

Instructions

- Place the two parts of the mounting bracket on the saddle rail, as illustrated. Insert the bolt(s) and tighten using the Allen key.

將扣具如圖所示·依序擺放所屬位置並拴緊螺絲

- Simply push the saddle bag buckle frame onto the buckle until it clicks into place.

公扣鎖上後再與座墊袋的母扣結合·扣回需有『卡!』的一聲·即完成組裝程序

- To remove the saddle bag, squeeze the two sides of the buckle and pull the bag off.

按壓母扣突出的兩側·即可將袋子卸除

LT-25

Install the buckle on the horizontal part of saddle rail.
請將扣具安裝在座弓水平線上

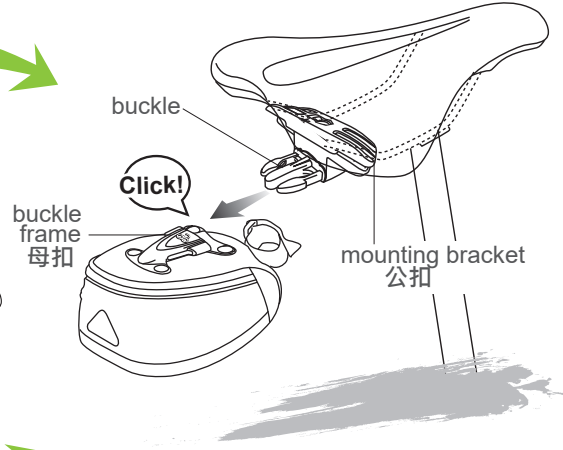
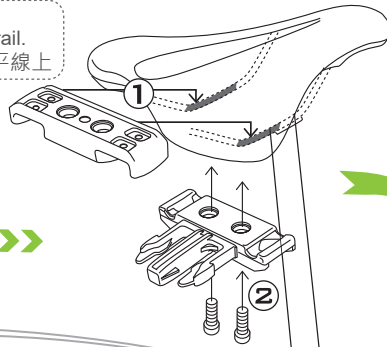
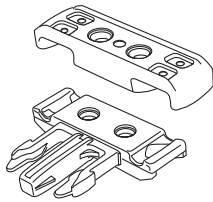

LT-29

Install the buckle on the lean part of saddle rail.
請將扣具安裝在座弓傾斜端上

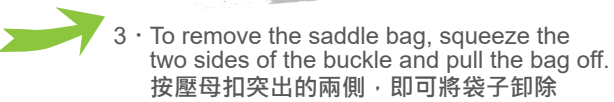
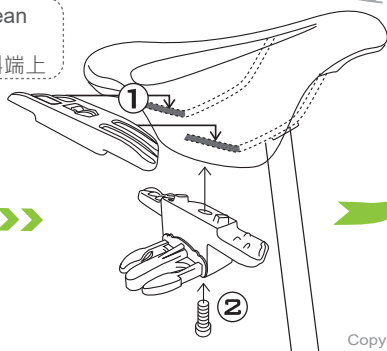
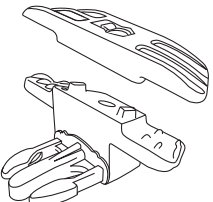

Copyright © 2013 SHINE-HO KNAPSACK & BAG MFG. CO., LTD. All rights reserved.

LT-26 Quick Release Buckle

Instructions

- Place the two parts of the mounting bracket on the saddle rail, as illustrated. Insert the bolt(s) and tighten using the Allen key.

將扣具如圖所示·依序擺放所屬位置並拴緊螺絲

- Simply push the saddle bag buckle frame onto the buckle until it clicks into place.

公扣鎖上後再與座墊袋的母扣結合·扣回需有『卡!』的一聲·即完成組裝程序

- To remove the saddle bag, squeeze the two sides of the buckle and pull the bag off.

按壓母扣突出的兩側·即可將袋子卸除

LT-26

Install the buckle on the lean part of saddle rail.
請將扣具安裝在座弓傾斜端上

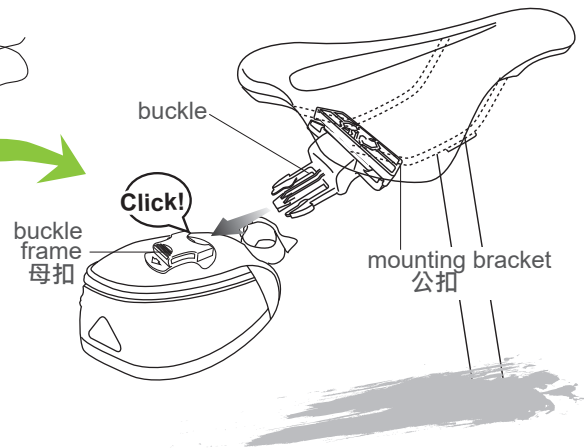
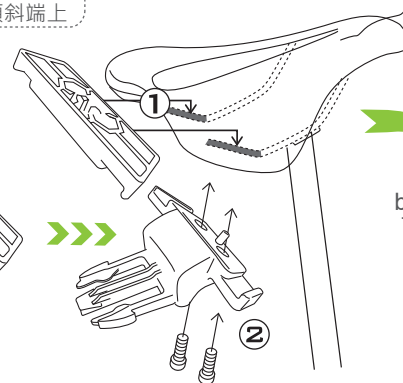
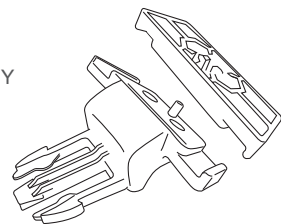

EN/CH ver. 4.0 2013/7/16
MADE IN TAIWAN

Can not be used under temperature of -4°F / -20°C
扣具使用溫度規範不得低於

LT-27 Quick Release Buckle

Instructions

- 1 • Please follow the instruction to install your saddle bag.
請您遵照下面的步驟來安裝您的座墊袋。
請您遵照下面的步驟來安裝您的座墊包。

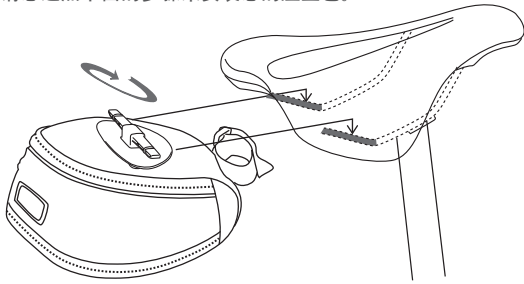

- 3 • Adjust the T-bar buckle until the both ends are even.
請調整T字型扣具至平穩的狀態。
請調整T字型扣具至平穩的狀態。

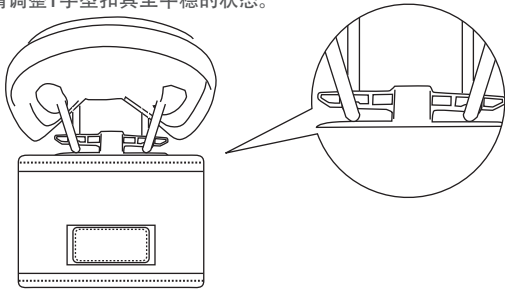

EN/CH ver. 3.0 2013/7/16
MADE IN TAIWAN

Can not be used under temperature of

扣具使用溫度規範不得低於
扣具使用溫度規範不得低於
-4°F / -20°C



Copyright © 2013 SHINE-HO KNAPSACK & BAG MFG. CO., LTD. All rights reserved.

- 2 • Place either one of the T-bar buckle on the saddle rail, as illustrated. Then, push the other end of T-bar buckle and twist saddle bag until the saddle bag is installed. 將T字型扣具的任一邊卡入座弓，再將另外一邊的扣具推入並旋轉座墊袋直到座墊袋安裝妥當。 將T字型扣具的任一邊卡入座弓，再將另外一邊的扣具推入並旋轉座墊包直到座墊包安裝妥當。



- 4 • Secure saddle bag to seat post by using Velcro strap.
將黏扣帶固定在座管上以確保袋包穩固。
將魔术贴固定在座管上以確保袋包穩固。



- 5 • To remove the saddle bag, simply release the Velcro strap from seat post. Then, twist the T-bar buckle to release saddle bag from saddle rail. 如要解除安裝，首先將黏扣帶解開，然後將T字型扣具的任一端扭轉到另一邊即可將座墊袋取下。 如要卸載，首先將魔鬼沾解開，然後將T字型扣具的任一端扭轉到另一邊即可將座墊包取下。

 **LOTUS**

Quick Release System

LT-28

Warning -Improper installation or use may result in serious accident and/or injury. For proper installation, please see the instruction or contact your local dealers.

How to install the saddle bag quick release system to your bicycle:

1.

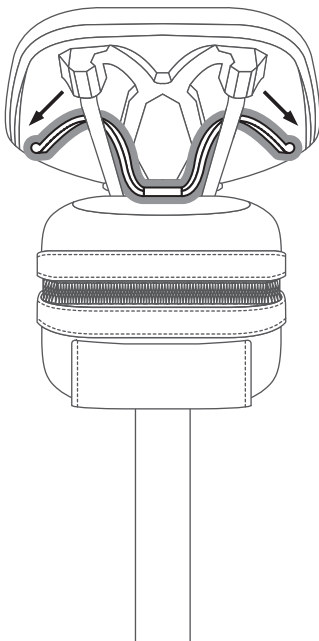

2.

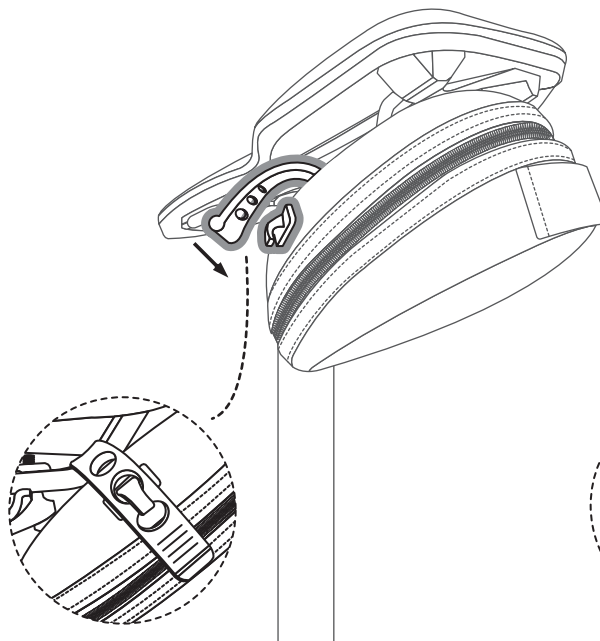

3.

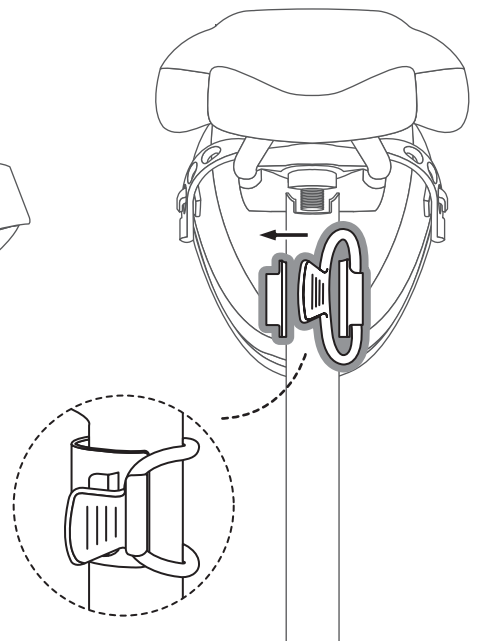

TYPE A.

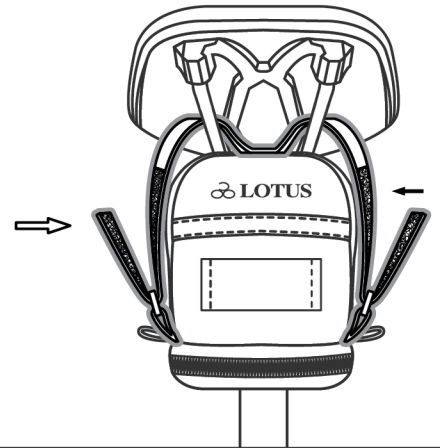
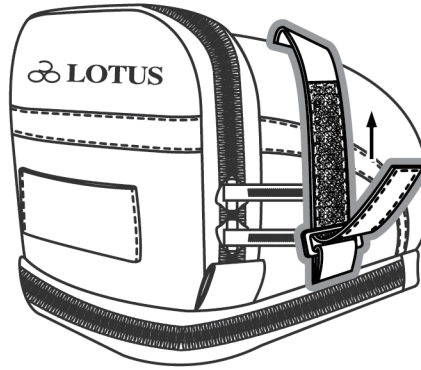
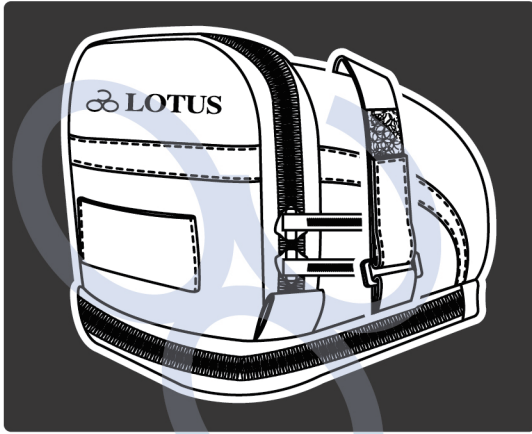

TYPE B.

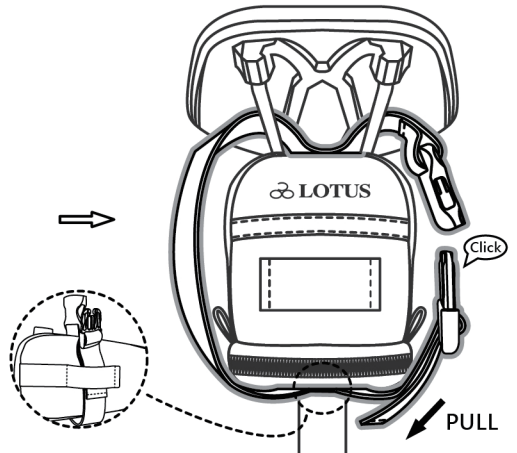
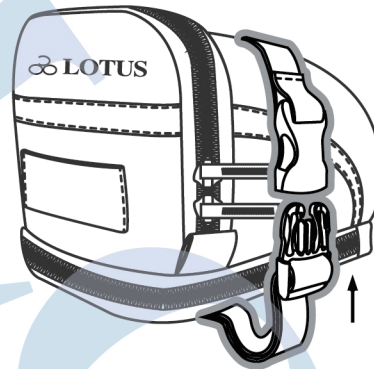
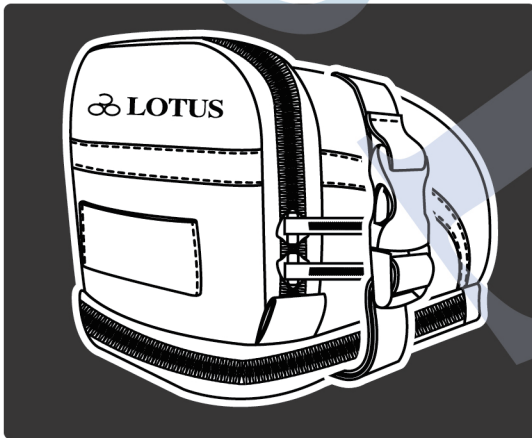

TYPE C.

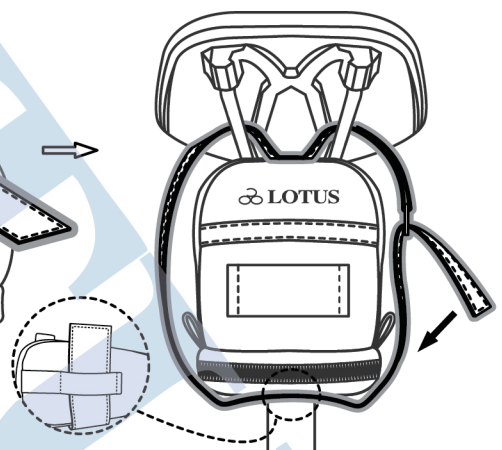
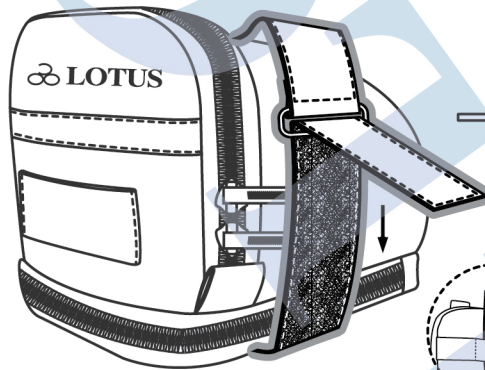
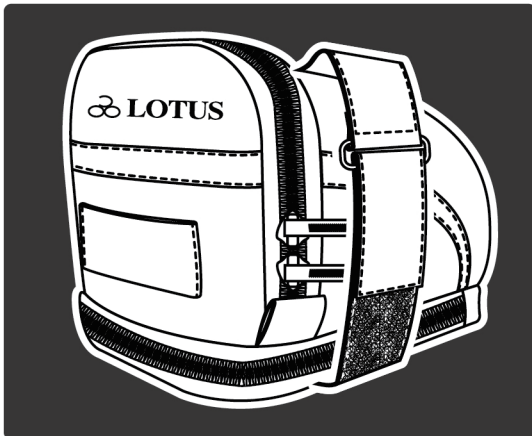

TYPE D.

